

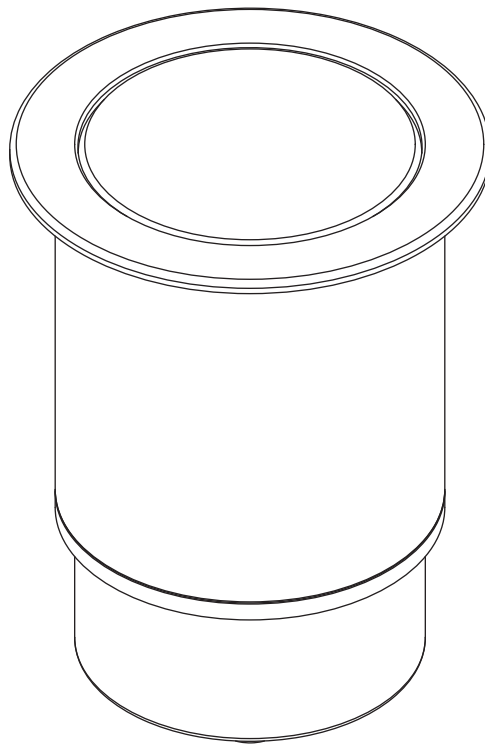

Vole Type X

Installation and Maintenance Instructions



IMPORTANT: All wiring connections must be made before switching on mains power.

 Xicato LED Module

 This product should not be disposed of in your general waste

 Please retain these instructions for future reference

 Class III - Extra Low Voltage

IP66 Dust tight and protected against powerful jets of water.

 Suitable for Exterior Use

 European Conformity

Electrical Supply

Installation must be carried out by a qualified electrician in accordance with BS 7671:2008 Wiring Regulations. 230/240V AC 50/60Hz mains supply to a suitable 48V DC PSU.

Ground recessed luminaire suitable for use in Zone 2 applications as defined by BS EN 60598-2-13 table A1. Suitable for use in restricted accessible areas (e.g. pedestrians and pedal cycles only).

Site conditions: LED equipment is more susceptible to static damage and overvoltage than previous technology. Before handling or connecting to the mains supply ensure that all MSL products are protected from static discharge and that the mains supply is to regulation. (230V +10 -6%)

This fitting is supplied with a Xicato LED module. Refer to the fitting label for the module version and wattage. More information on the module can be found at www.xicato.com/support

Mains cables must be double insulated, strain relieved and separated from E.L.V output cables.

This unit requires a 48V constant voltage PSU.

Observe polarity:
Positive (+) is marked as RED.
Incorrect supply or reverse polarity can cause irreparable damage.

All connections must be made before switching on mains. If the supply is energised prior to making the connections to the fitting then the resulting surge will damage the LED.

All lighting equipment is delicate and easily damaged through misuse or inappropriate installation (mechanical or electrical). Repairs and replacements may cause delays and will be chargeable. Contact MSL for support if required. For full warranty terms & conditions please visit our website.

The IP rating stated is applicable only when the fitting has been installed as per these instructions.

The light source contained in this luminaire shall only be replaced by the manufacturer or his service agent or a similar qualified person.

Dimming control circuit source must be of SELV insulation class.

Max exposed surface temperature 58°C at 25°C ambient

Installation

Check that the mounting surface is suitable for the installation of this fitting. Max static load 5kN.

Fitting Weight : 0.5kg.

A 60-65 mm diameter hole is required for mounting.

Step 1 Make mains connections to SELV LED driver and extra low voltage connections to the fitting.

Step 2 Insert the fitting into the cut-out and secure in place with silicone or similar.

Ensure supply driver and connectors are housed indoors OR in a suitably IP rated enclosure. Cable ends must be suitably waterproofed. Inspect supply cables before installation to ensure there is no damage which will allow water to enter the fitting.

After opening the sealed portion of the luminaire for any reason, MSL recommends running the fitting for 15 minutes with the lid open to expel moisture before closing it up. This will prevent condensation on the lens and protect the fitting from corrosion.

WARNING: Do not look at exposed LED lamps in operation. Eye injury can result.

Cleaning:

Fully isolate the fitting and allow to cool.

Clean the fitting with a slightly damp lint free cloth from a mild solution of soap and water. The fitting must be completely dry before reconnecting power.

Incompatible or abrasive chemicals can damage the fitting, contact MSL for advice if required.

STOANE LIGHTING

EQUIPMENT DESIGN + MANUFACTURE

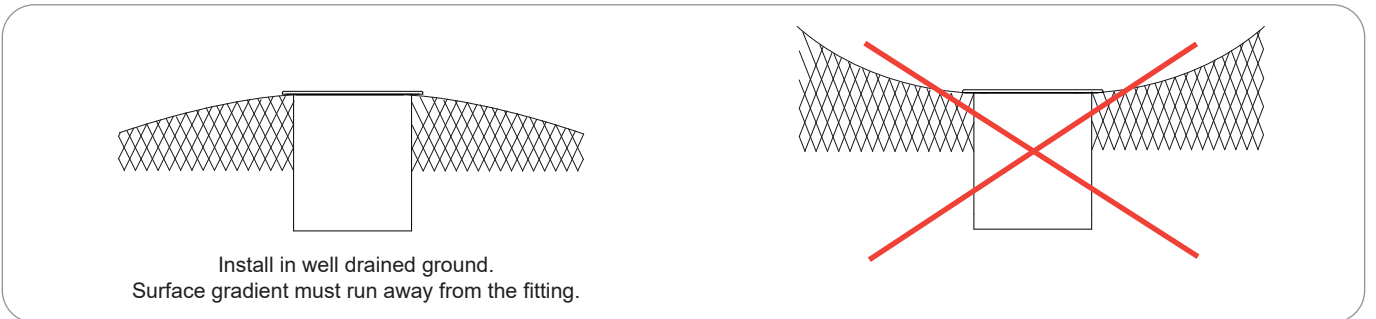
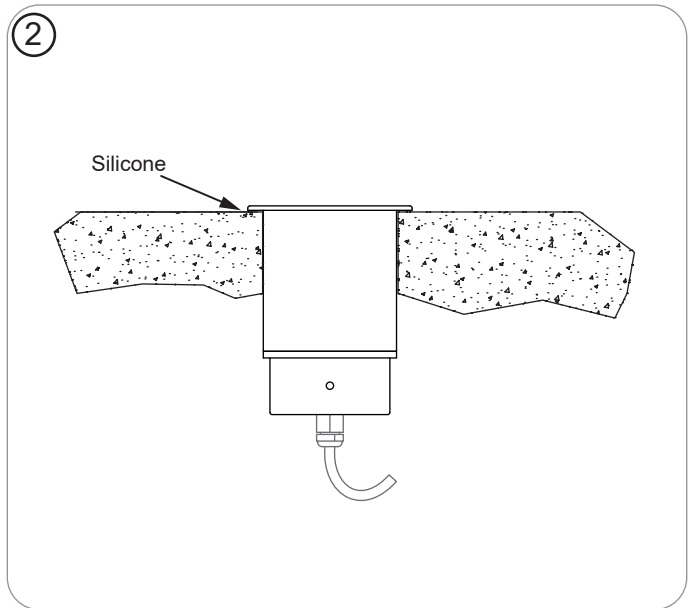
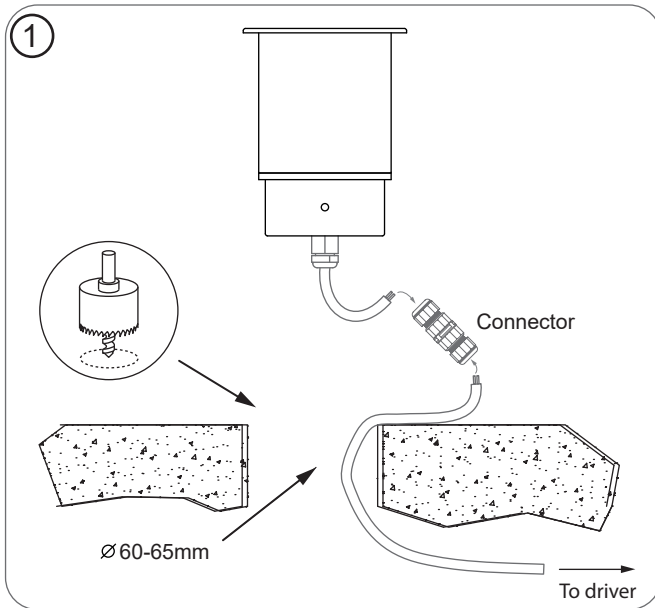

OPTIC CHANGE

Fully isolate and allow fitting to cool sufficiently before handling .

Step 1 Unscrew the bezel from the heatsink to access optic and accessories.

Step 2 Replace optic and accessories as required.

Step 3 Reattach heatsink by twisting it in a clockwise direction.

The heatsink must be fully tightened to ensure a watertight seal has been created.

